

Număr model :
2312-320-84

Typ:
320

ESENA

RTV 2D1S

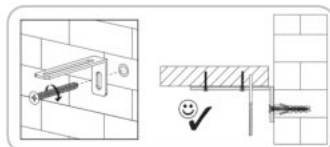
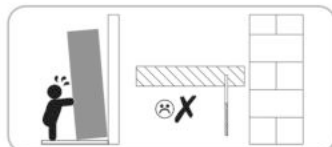
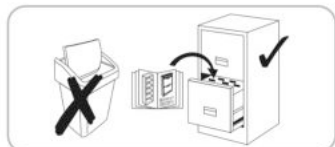
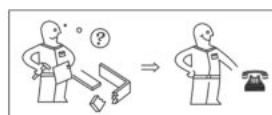
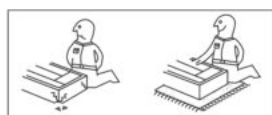
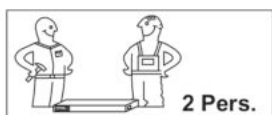

Ø8

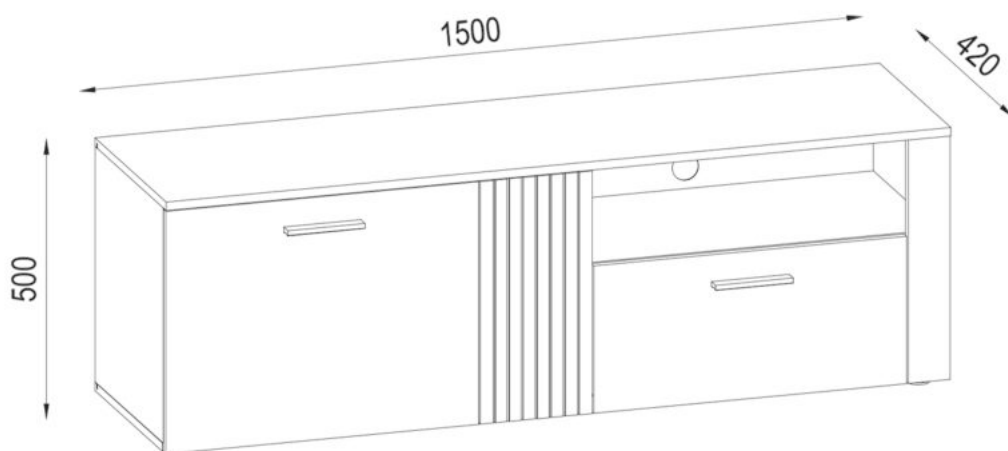

strângere



introducere prin apă sare



măsurare



apăsare



introducere prin bătaie



Întoarceți - roțiți

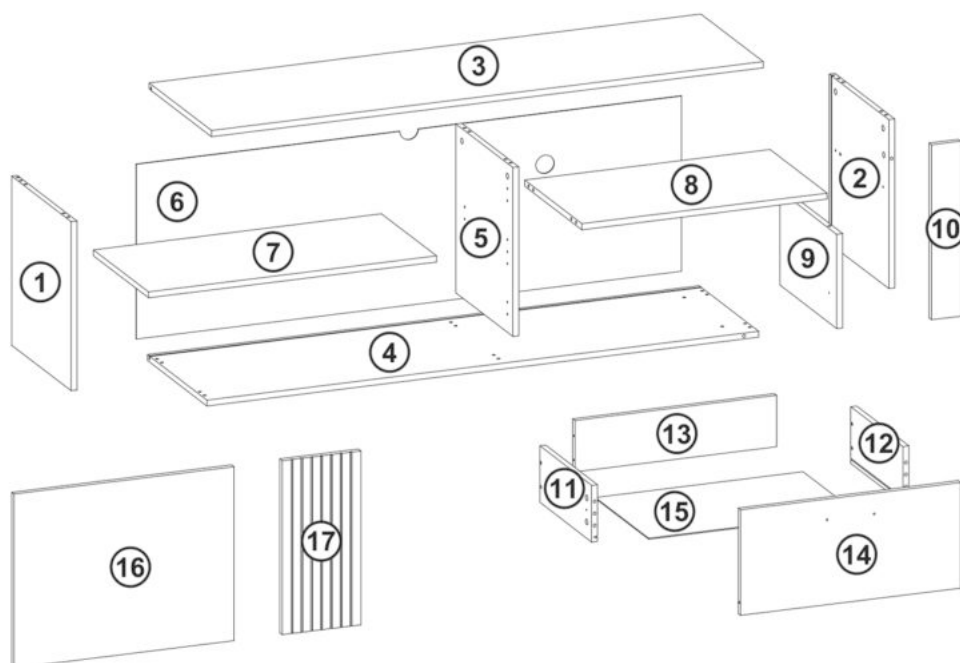















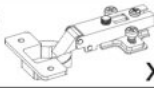





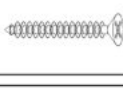

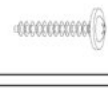

max. 3KG = 15 max. 5KG = 7 8 max. 10KG = 3 4

A	B (mm)		C	D
1	448	400	16	x1 1/2
2	448	400	16	x1 1/2
3	1500	420	16	x1 2/2
4	1500	400	16	x1 2/2
5	448	384	16	x1 1/2
6	464	1482	2,5	x1 2/2
7	783	370	16	x1 2/2
8	667	384	16	x1 2/2
9	250	384	16	x1 1/2

A	B (mm)		C	D
10	464	80	16	x1 2/2
11	350	150	16	x1 1/2
12	350	150	16	x1 1/2
13	548	136	16	x1 2/2
14	598	280	16	x1 2/2
15	564	358	2,5	x1 1/2
16	598	461	16	x1 1/2
17	461	214	16	x1 1/2
B1				1/2

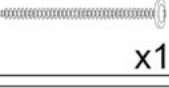

A1 15x12  x16	C2 44mm  x16	B2 8x30  x22
FA1 4mm  x1	F3 6,3x50  x10	O3 Ø18  x6
K6 Ø35  x4	J65 128/148  x2	O4 Ø18  x5
M1 10x10x15  x10	P14 45x20  x5	N1 Ø6  x4
D25 4x25  x5	DA21 4,2x16  x8	DB2 4x25  x4
E5 5x11  x4	D11 3,5x16  x10	D10 3x16  x4
R10 Ø10  x2	I6 350  x1	Y36 75x32x15  x1
	Y37 8x50  x1	Y35 4,2x65  x1
		R6  x1

Stimată clientă, stimat client, Îți mulțumim pentru achiziția unei piese de mobilier din programul nostru de interior pentru utilizarea exclusivă în încăperi private. Vă rugăm să verificați integralitatea volumului livrării și să citiți cu atenție informațiile importante de mai jos înaintea montajului și să le păstrați pentru utilizarea ulterioară, inclusiv de către terți. Piesele noastre de mobilier trebuie să fie folosite conform destinației. Utilizarea neconformă destinației poate cauza daune materiale sau în anumite circumstanțe vătămări corporale. Piesele de mobilier nu sunt jucării. Producătorul sau comerciantul nu își asumă răspunderea pentru daune, care sunt provocate prin utilizarea neconformă destinației sau prin manipularea greșită.

ATENȚIE: Copiii și persoanele cu handicap psihic trebuie să fie ținute întotdeauna la distanță față de piese de mobilier, obiecte ascuțite, piese mici și materiale de ambalaj, există pericolul de vătămare și/sau asfixiere.

MONTAJ: Pentru montaj, vă rugăm să vă orientați după instrucțiunile noastre de funcționare, de operare, de instalare sau de montaj și să respectați în special avertismentele și indicațiile de siguranță. Dacă instrucțiunile nu au fost respectate, acest fapt poate să provoace leziuni la persoane sau daune la mobilier / pot să devină un risc de siguranță. Dacă aveți dificultăți la asamblare / montaj, vă rugăm să contactați echipa noastră de service. Aceasta vă stă alături cu sfaturi și asistență. Montajul poate fi efectuat numai de către persoane calificate. În cazul modificărilor la produs/piese ale produsului, în cazul schimbării, respectiv al înlocuirii pieselor / materialelor de consum, care nu provin de la producător/comerciant, nu se poate prelua nicio răspundere pentru daune.

Dacă marfa include mijloace de montare pe perete, precum dibluri și șuruburi, acestea sunt destinate exclusiv pentru utilizarea la pereți din materiale masive și unitare. O fixare este numai așa de bună ca legătura dintre mijlocul de fixare și perete. Vă rugăm să verificați atât în cazul pieselor de mobilier de sine stătătoare cât și al celor suspendate, înainte de fixarea lor, perețele dumneavoastră cu privire la adecvarea în acest sens și utilizați numai mijloacele de montare adecvate. Înaintea eventualelor lucrări de găurire, asigurați-vă că nu se află cabluri în zona de găurire. În final, montatorul este responsabil pentru fixarea sigură de perete. Aceasta privește și instalarea articolelor electrice, precum și celelalte accesorii tehnice constructive. Montarea / instalarea articolelor electrice, precum și a altor accesorii relevante constructiv trebuie să fie efectuate numai de personal calificat autorizat. Toate instalațiile electrice, precum și tehnice constructive trebuie să fie executate conform standardelor respective valabile, respectiv normelor de siguranță din țara dumneavoastră. Pentru sursele de lumină vă rugăm să folosiți numai intensitățile admisibile ale corpurilor de iluminat. În cazul nerespectării numărului max. de Watt există pericol de incendiu din cauza supraîncălzirii. Trebuie să se omită acoperirea corpului de iluminat din cauza pericolului de incendiu. O funcționare perfectă a mobilierului este garantată numai în cazul unei amplasări verticale și orizontale. Ușile sunt ajustate în prealabil, însă trebuie eventual aliniată / reglate din nou din cauza condițiilor locale. Vă rugăm să respectați neapărat indicațiile de greutate privind sarcina maximă. Nu este permis să urcați pe mobilă. În cazul utilizării necorespunzătoare, poate să apară răsturnarea pieselor de mobilier. Pentru a preveni acest fapt, piesele de mobilier ar trebui asigurate întotdeauna împotriva răsturnării. În cazul suprasarcinilor/supraîncălzărilor (în special prin copii care se joacă, oameni, materiale sau alte acțiuni necorespunzătoare) există pericolul de rupere și leziune. Toate șuruburile, precum și punctele de îmbinare portante ar trebui strănse din nou după 5 până la 6 săptămâni, pentru a asigura o stabilitate permanentă.

ÎNGRIJIRE:-Indicații de îngrijire a mobilei- Vă rugăm să respectați indicațiile noastre cu privire la îngrijirea corectă a mobilei, astfel încât să vă bucurați cât de mult posibil de produsul nostru.

Pentru curățare, utilizați o lavetă de bumbac curată, uscată și moale. Dacă mobilierul dumneavoastră necesită o curățare temeinică, puteți să umeziți laveta cu puțină apă sau soluție de curățare a mobilei și apoi să uscați elementele curățate. Cel mai bine curățați piesele din metal și sticlă cu soluții de curățare a metalului și a sticlei uzuale din comerț conform instrucțiunilor de îngrijire de pe acestea. Soluțiile de curățare trebuie să poarte o indicație clară că sunt adecvate pentru îngrijirea mobilei. În niciun caz nu folosiți aparate de curățare cu abur, precum și substanțe caustice, abrazive sau alte substanțe al căror efect nu îl cunoașteți.

ATENȚIE: Suprafețele lucioase sunt protejate printr-foleie la livrare. Lăsați-o pe mobilă, până când este montată complet și curățată de praf. Elementele lucioase, de pe care s-a îndepărtat folia de protecție pot fi curățate și folosite abia după 72 ore (timp pentru întărire ulterioară la aerul din încăpere). Nu deteriorați suprafețele cu obiecte ascuțite și în niciun caz nu le expuneți radiației solare puternice.

ELIMINARE -Indicații privind eliminarea deșeurilor- De dragul mediului înconjurător, vă rugăm să eliminați deșeurile de ambalaj pe sortimentele în tomberoanele de deșeurii/reciclare prevăzute în acest scop și nu în natură. Piese de mobilier deteriorate sau inutilizabile pot fi predate la centre de reciclare speciale în scopul reciclării pieselor individuale. Piese de mobilier scoase din uz, dar încă funcționale nu trebuie eliminate imediat. Donați-le, de exemplu, la organizații caritabile.

Sperăm să vă bucurați de noul dumneavoastră mobilier.

1

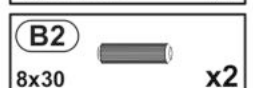
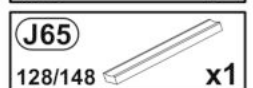
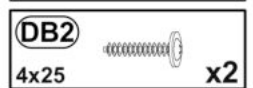
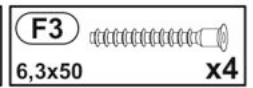
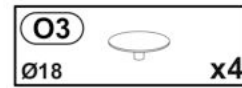
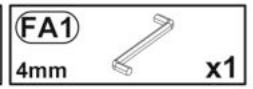
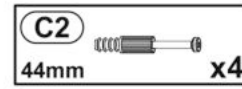
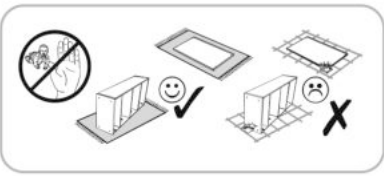

A

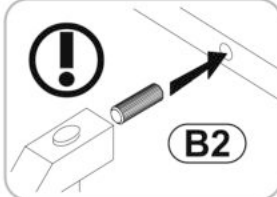
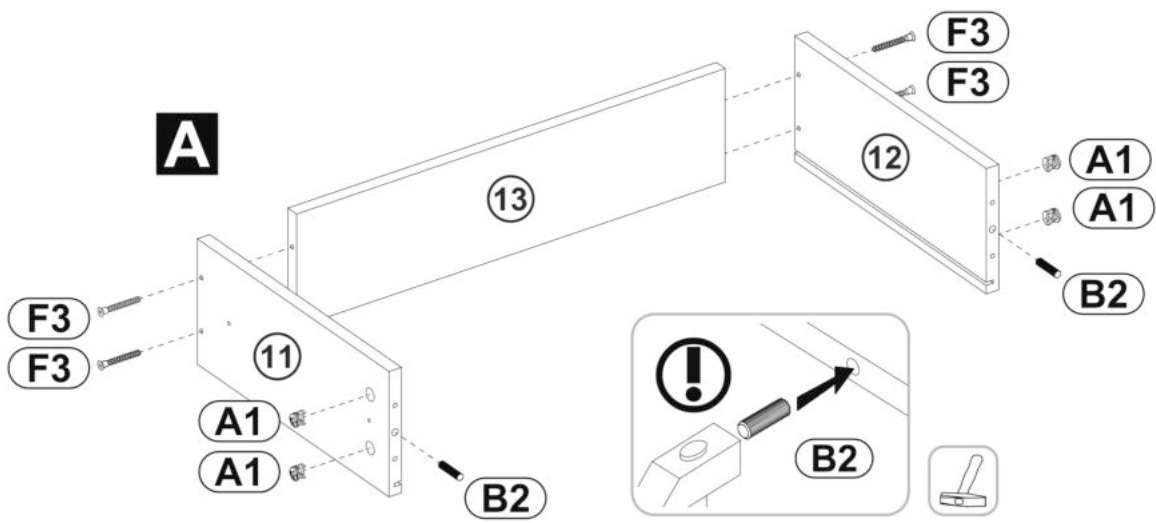

B

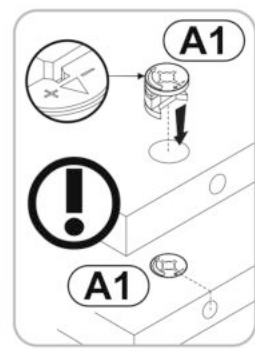
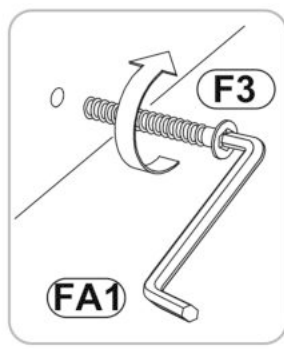
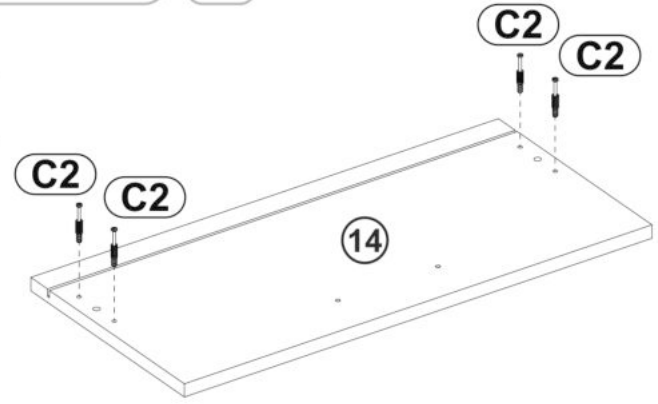

C

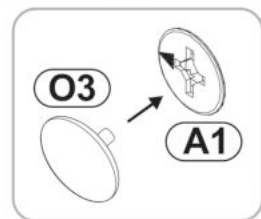
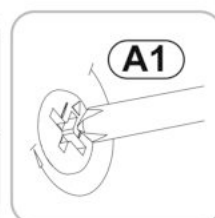
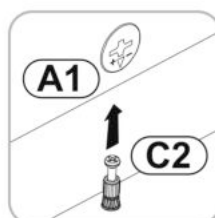
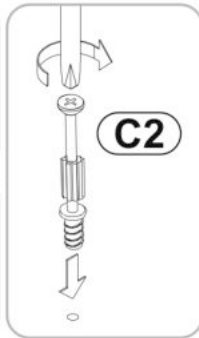
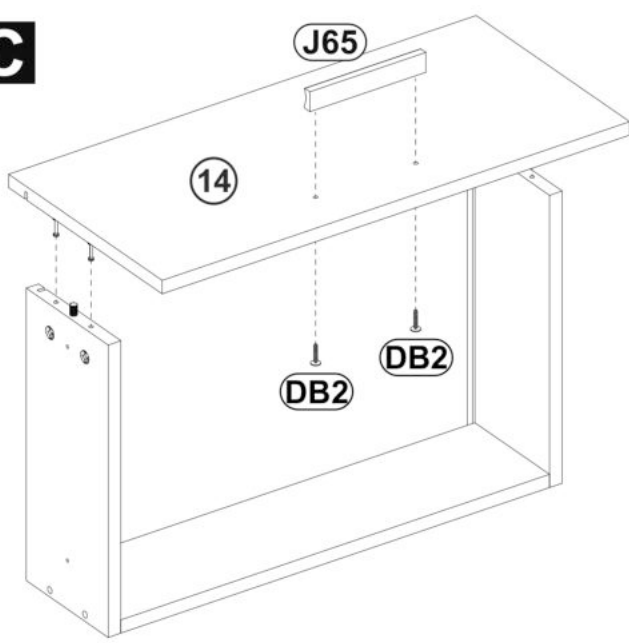

2

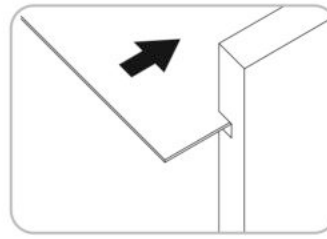
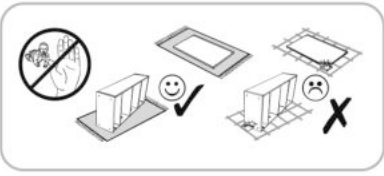

DA21
4,2x16 x4

I6
350 x1

D10
3,0x16 x4

D

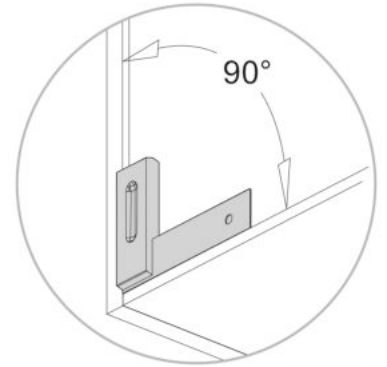
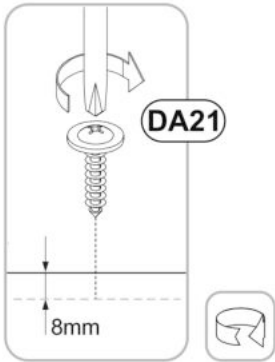
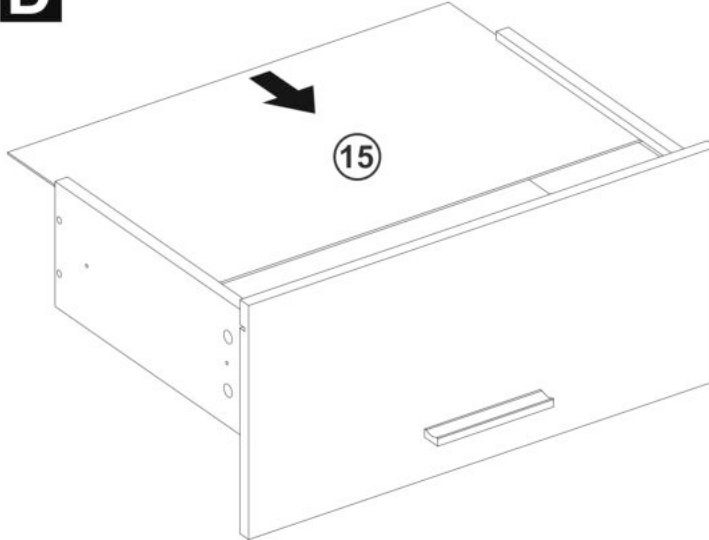

A=B

E

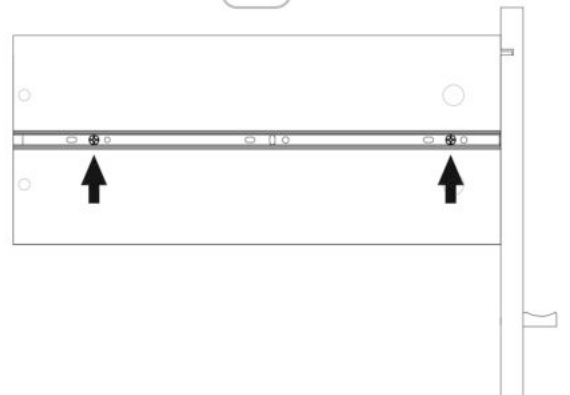
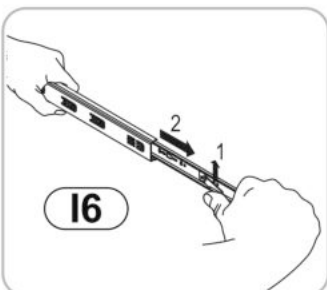
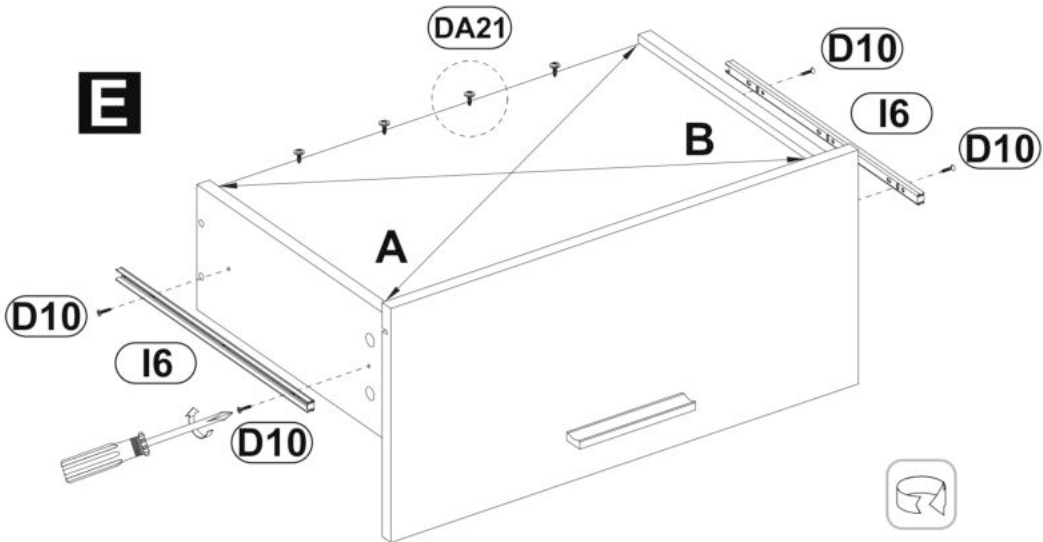

3

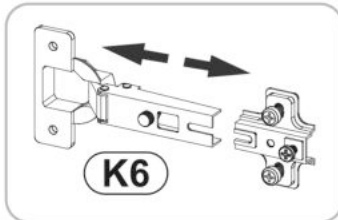
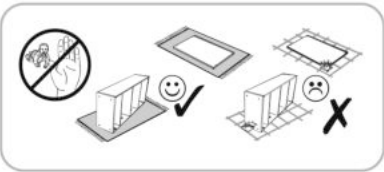

A1
15x12 x9

B2
8x30 x12

K6
Ø35 x2

C2
44mm x2

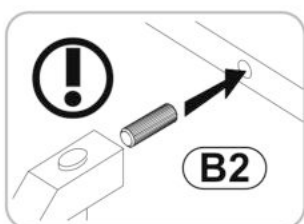
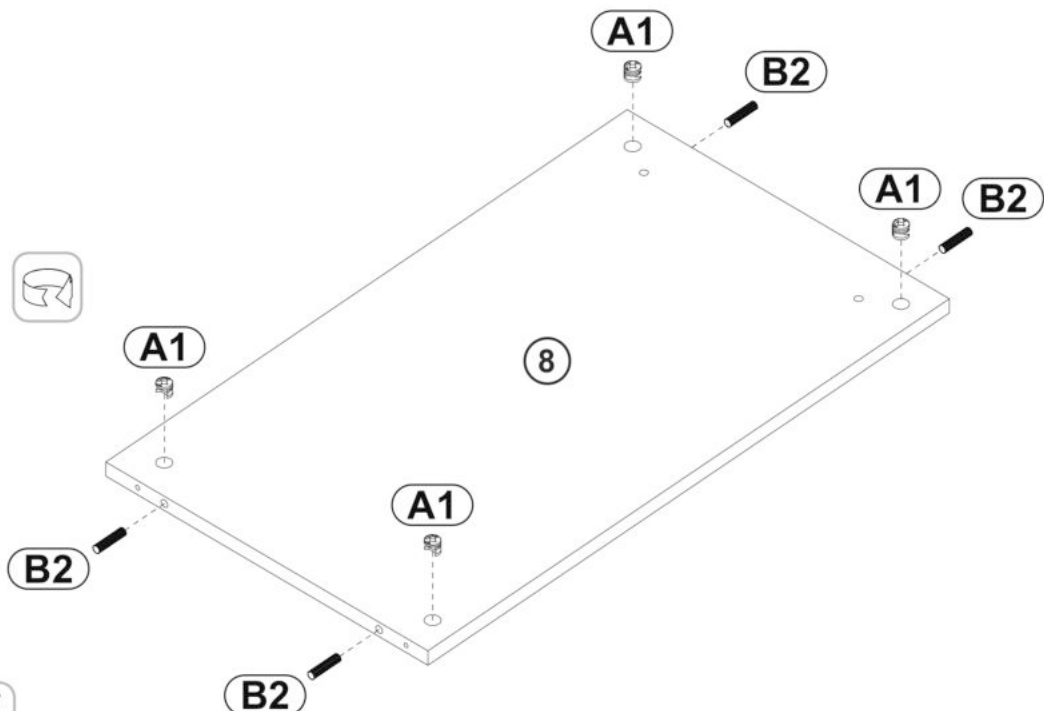
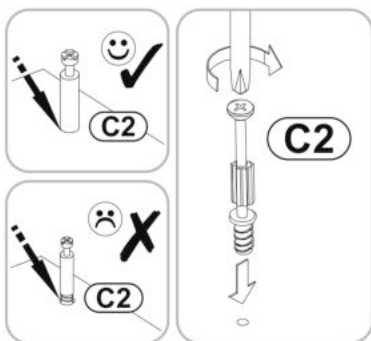
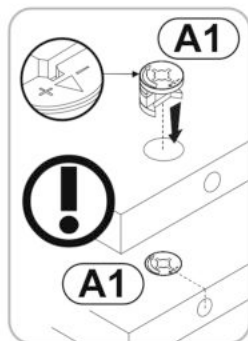
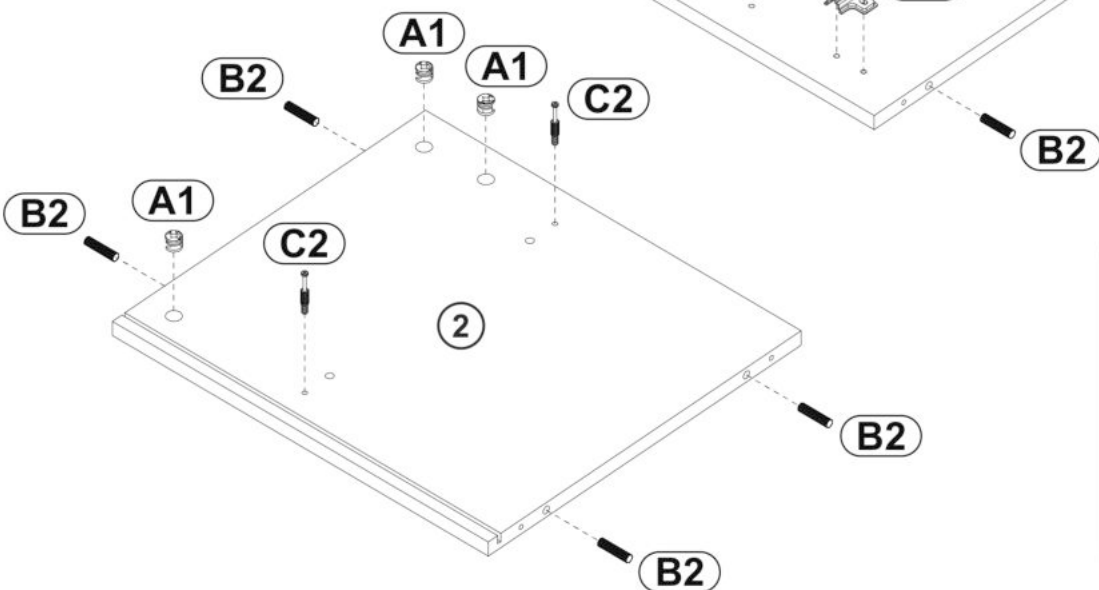
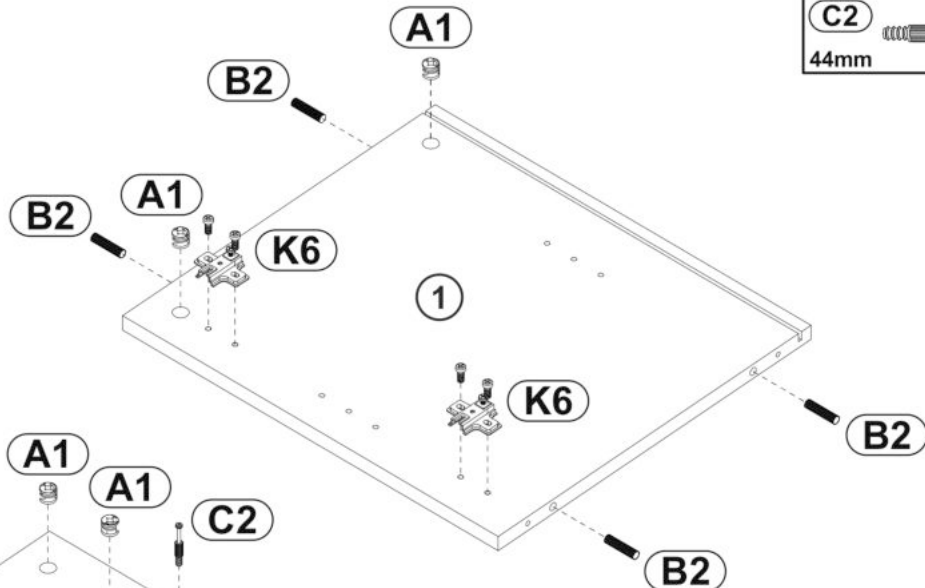
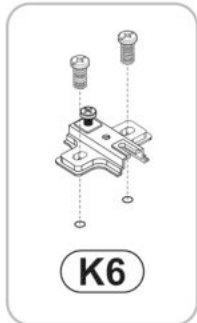

4

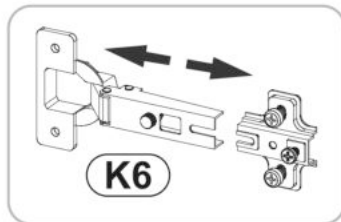
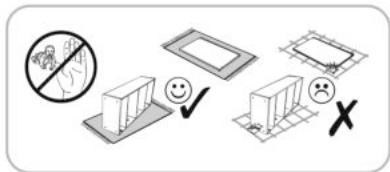

- A1** 15x12 x2
- C2** 44mm x2
- B2** 8x30 x8
- K6** Ø35 x2
- I6** 350 x1
- E5** 5x11 x4

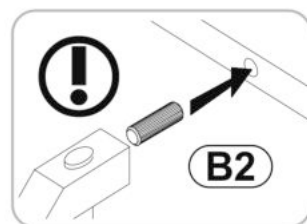
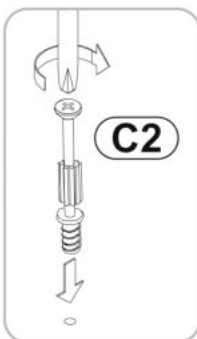
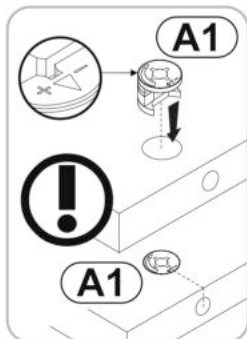
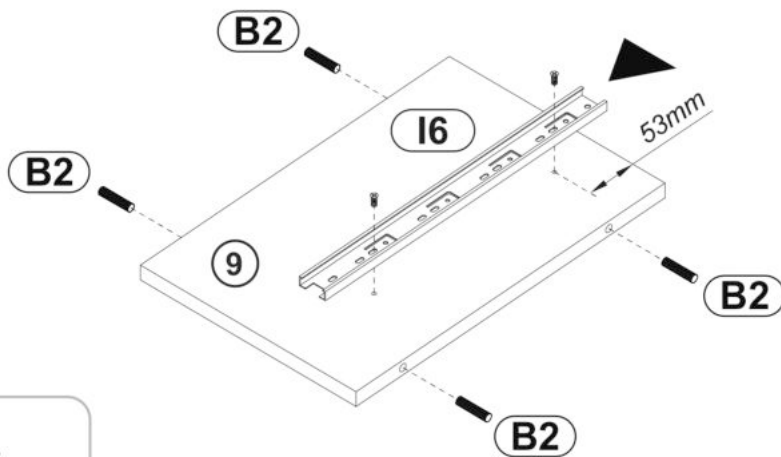
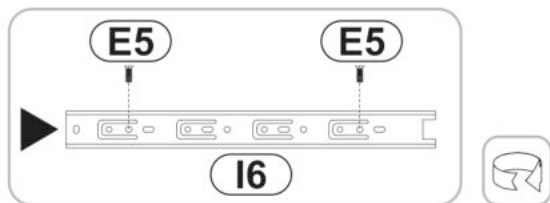
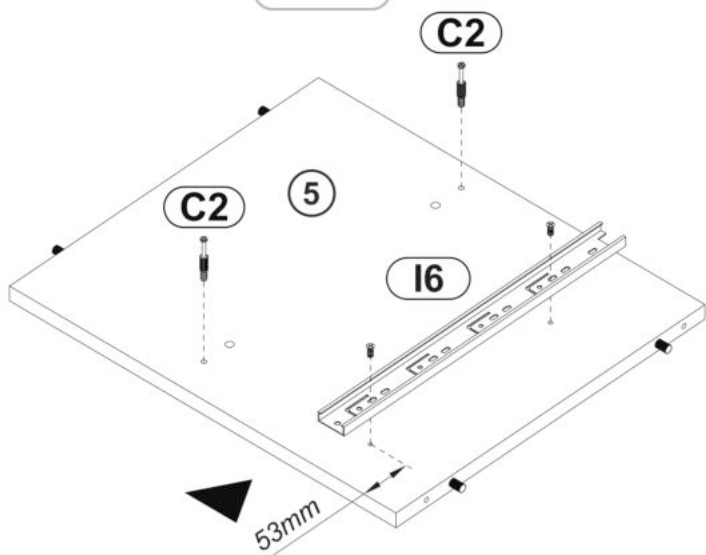
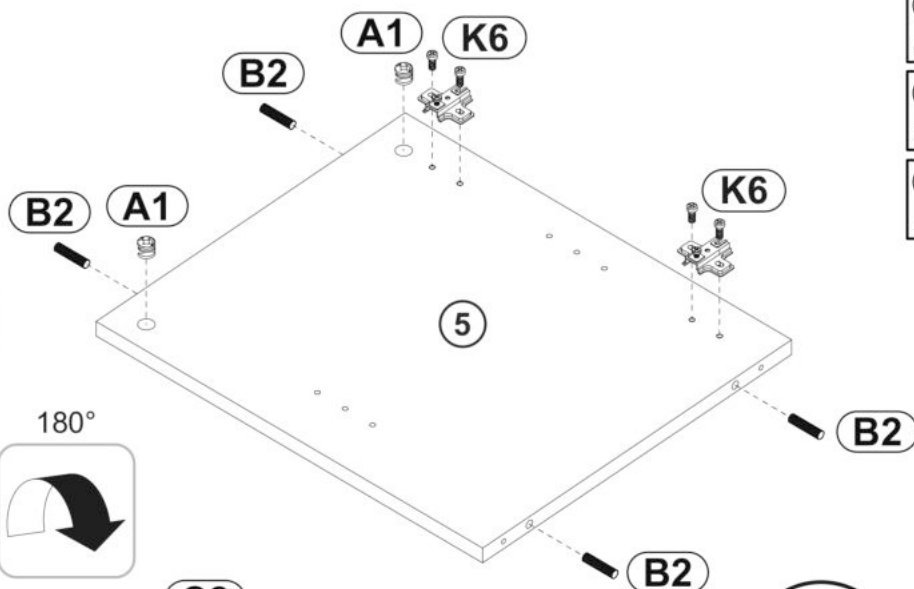
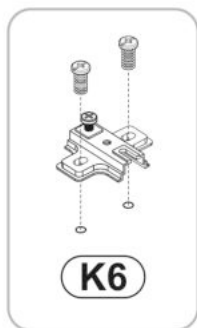

5

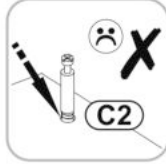
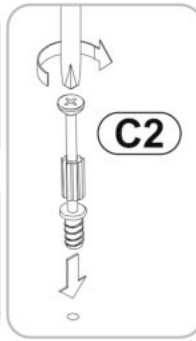
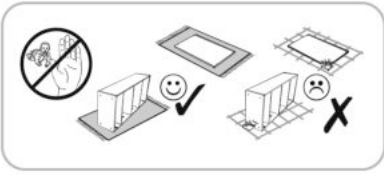

C2		x8
44mm		
A1		x1
15x12		
Y36		x1
75x32x15		
D11		x2
3,5x16		

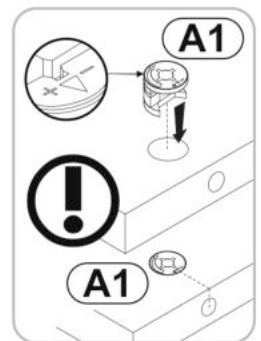
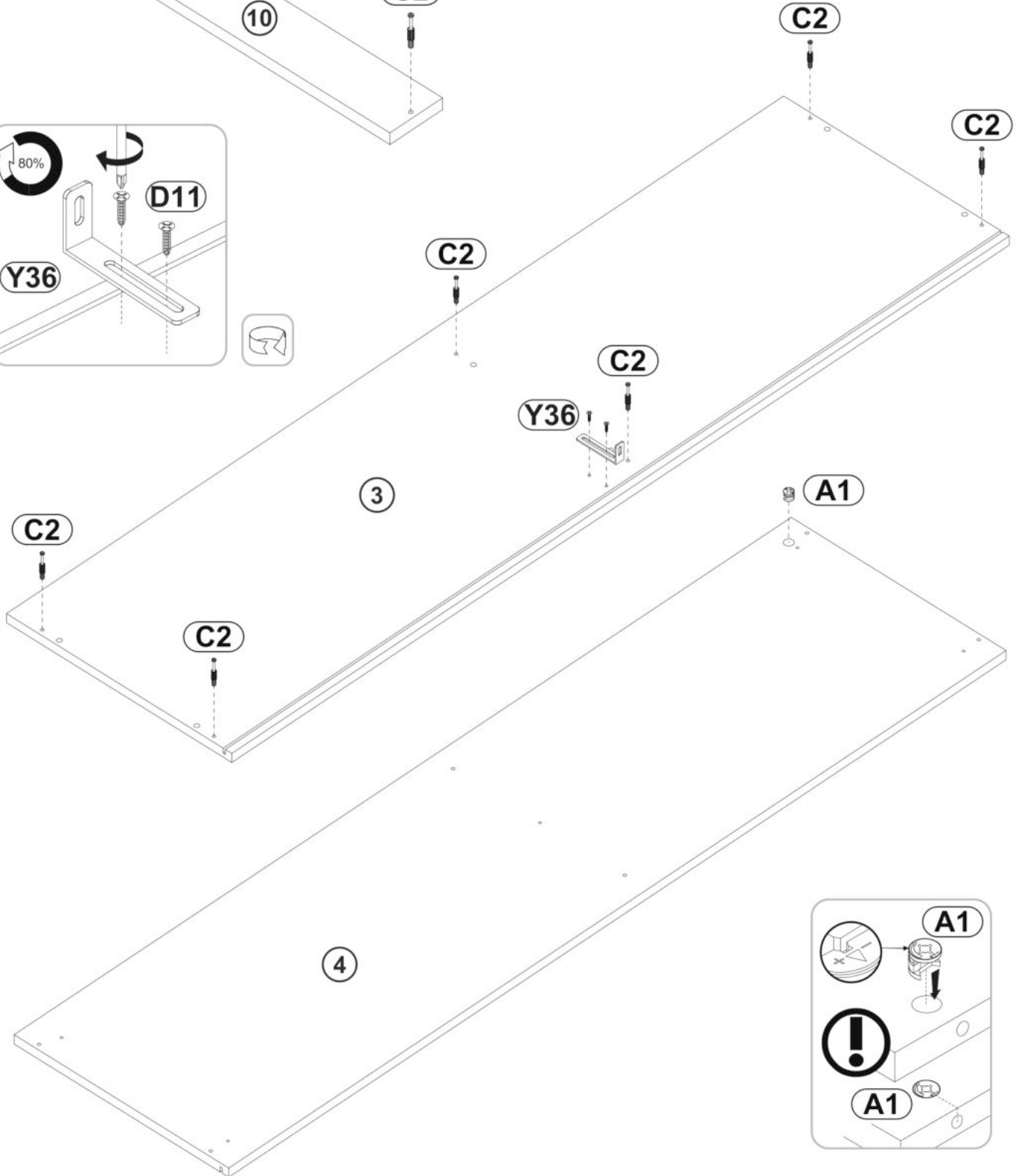
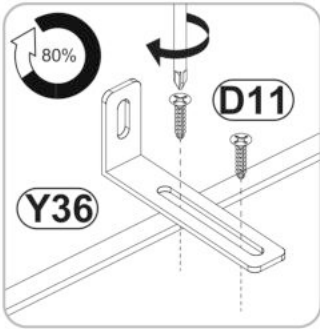
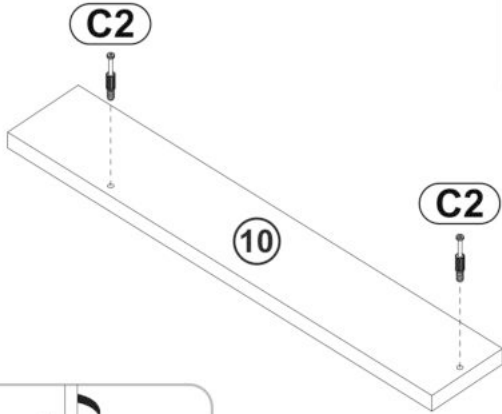

6

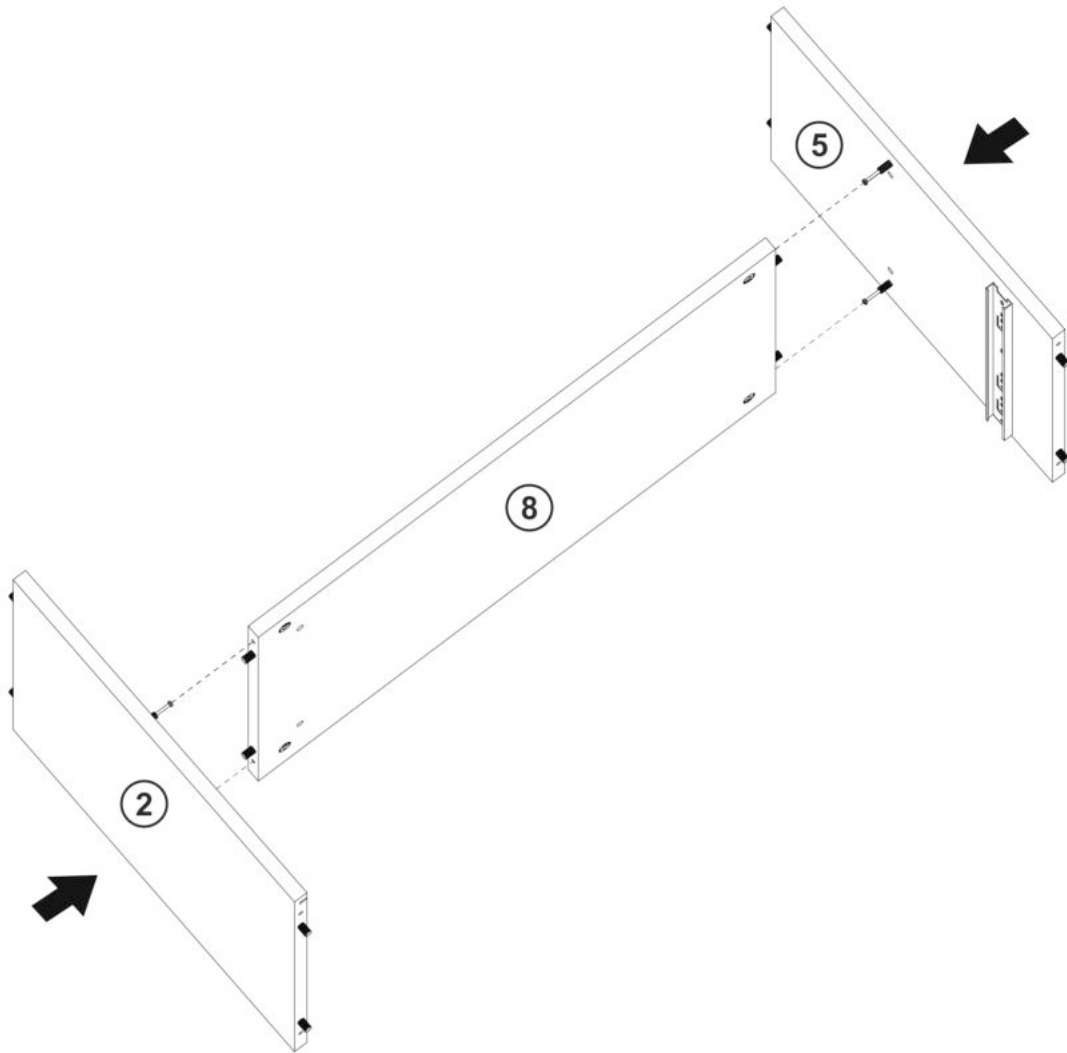
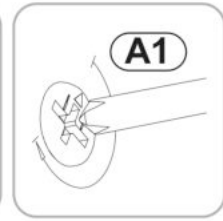
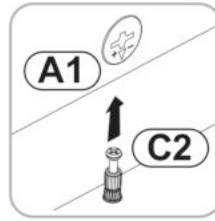
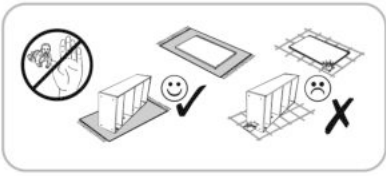

7

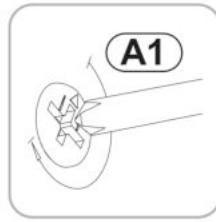
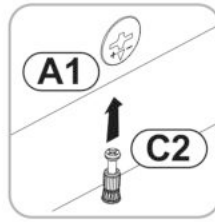
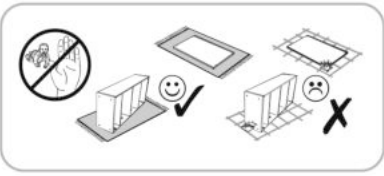

O4  **x4**
Ø18

O3  **x2**
Ø18

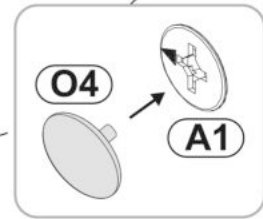
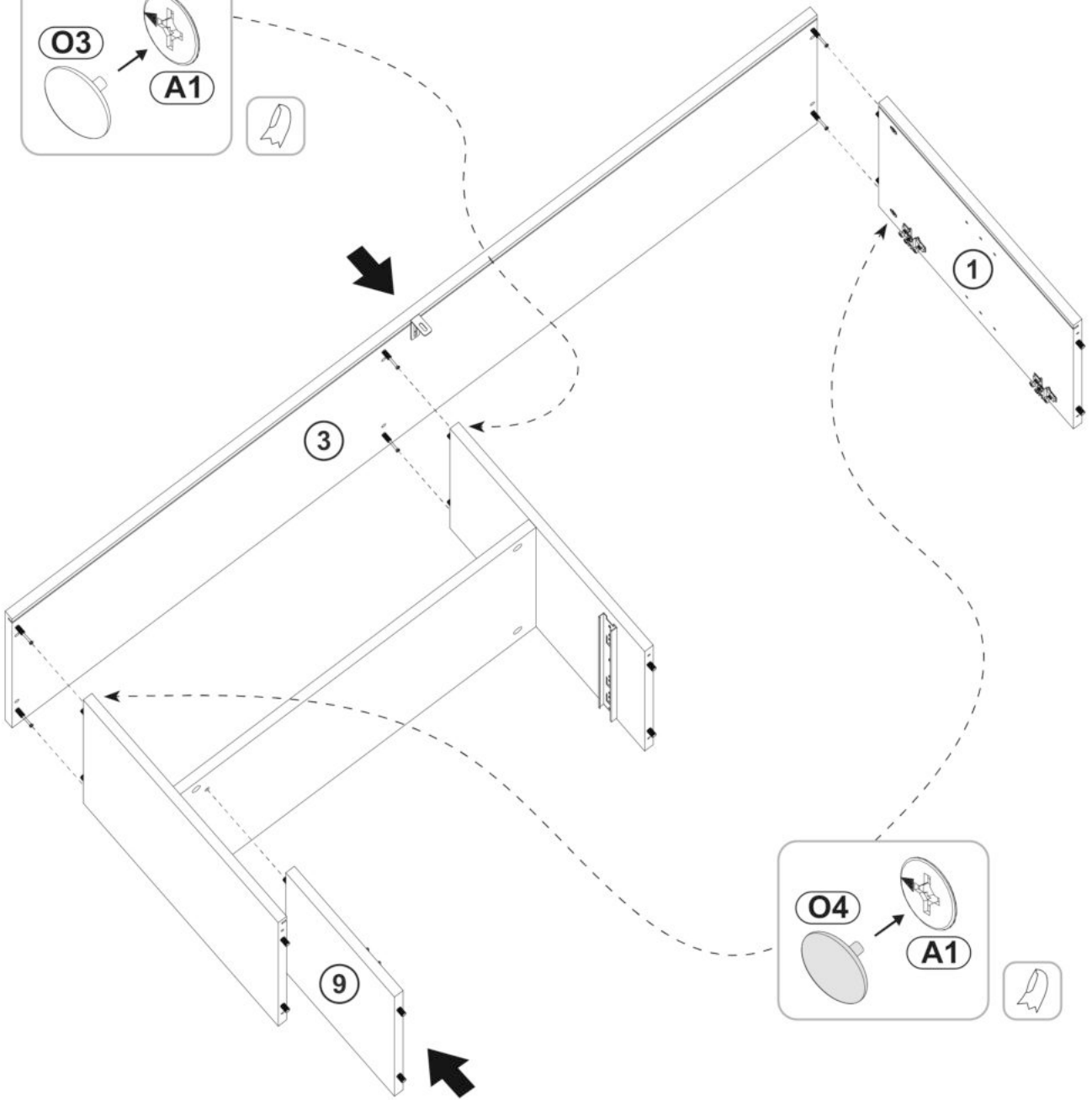
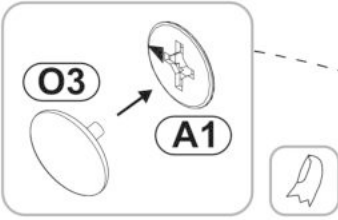

8

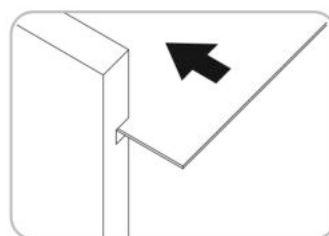
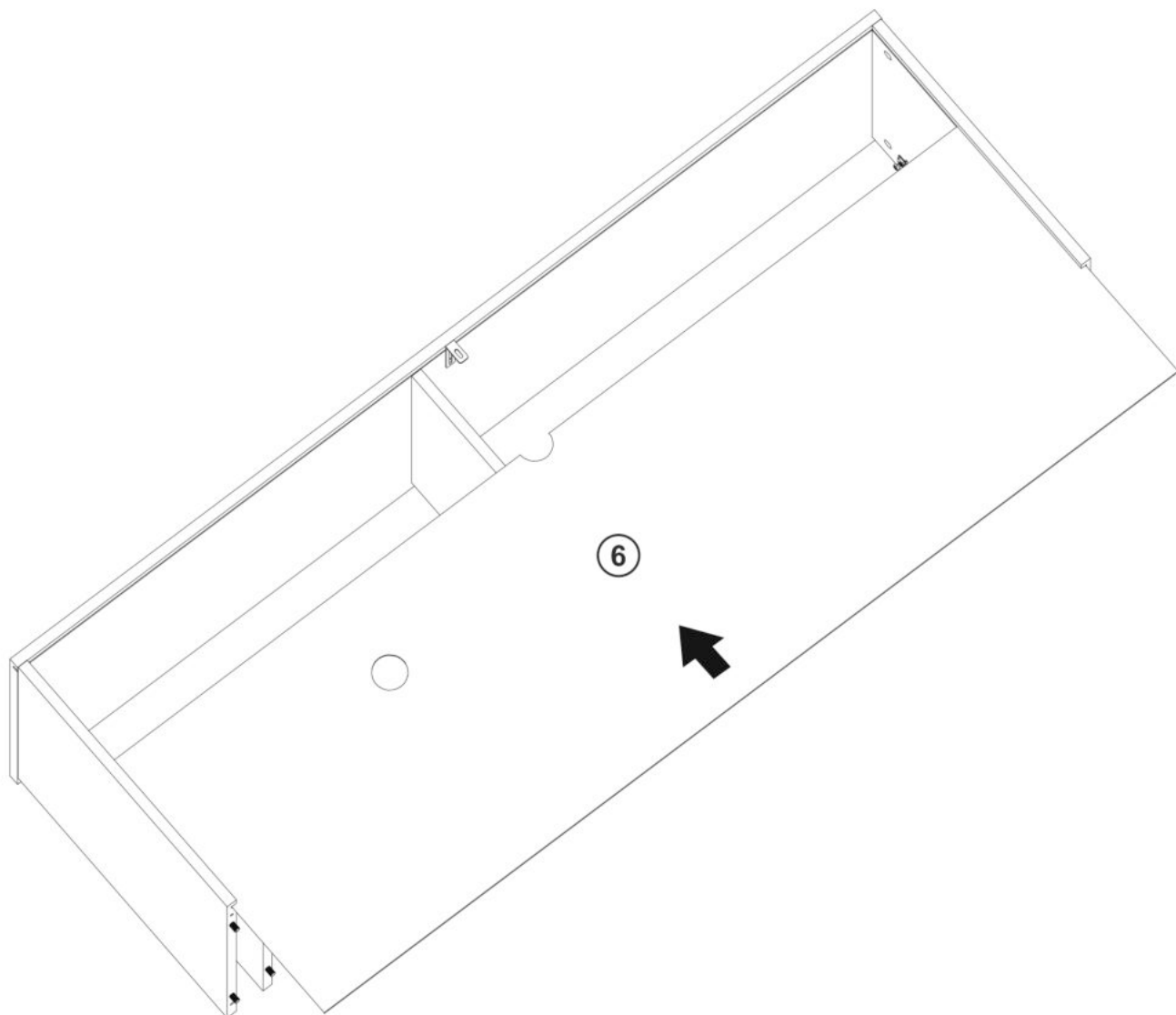
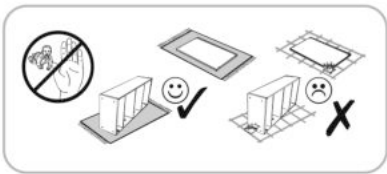

9

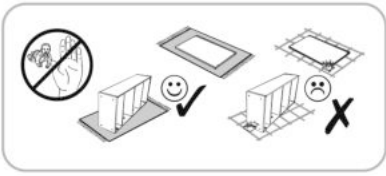

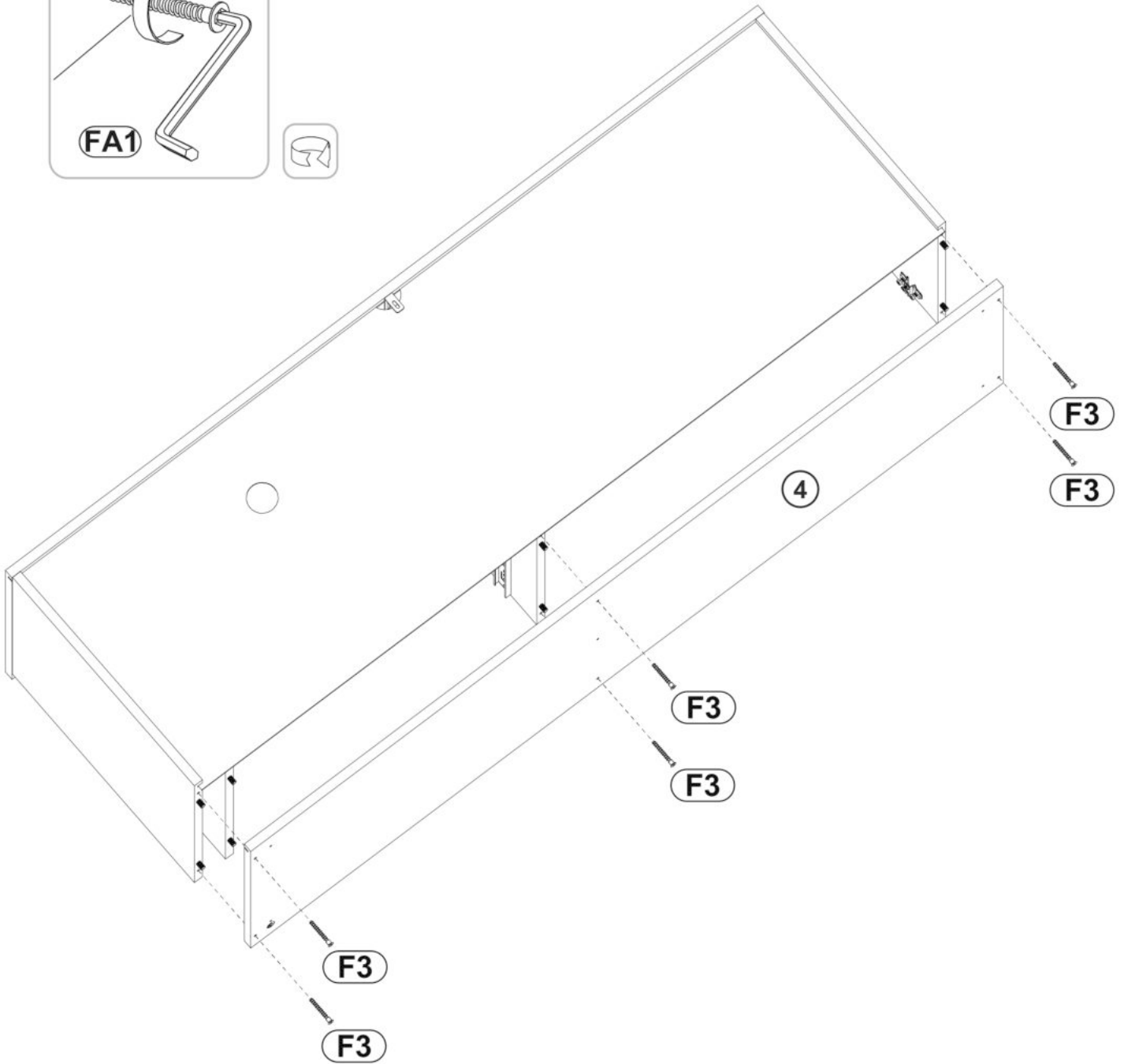
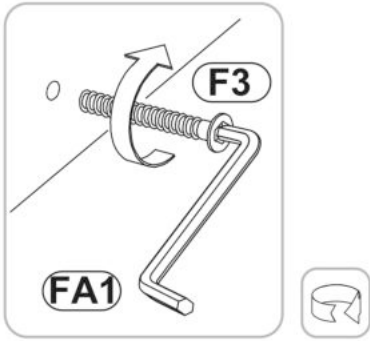

FA1
4mm x1

F3
6,3x50 x6

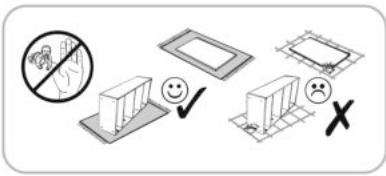

10



O4  **x1**
Ø18

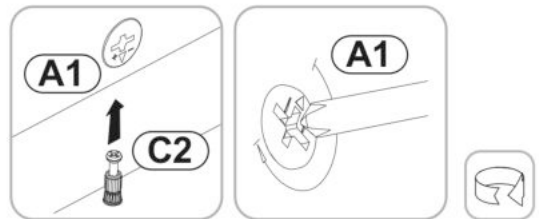
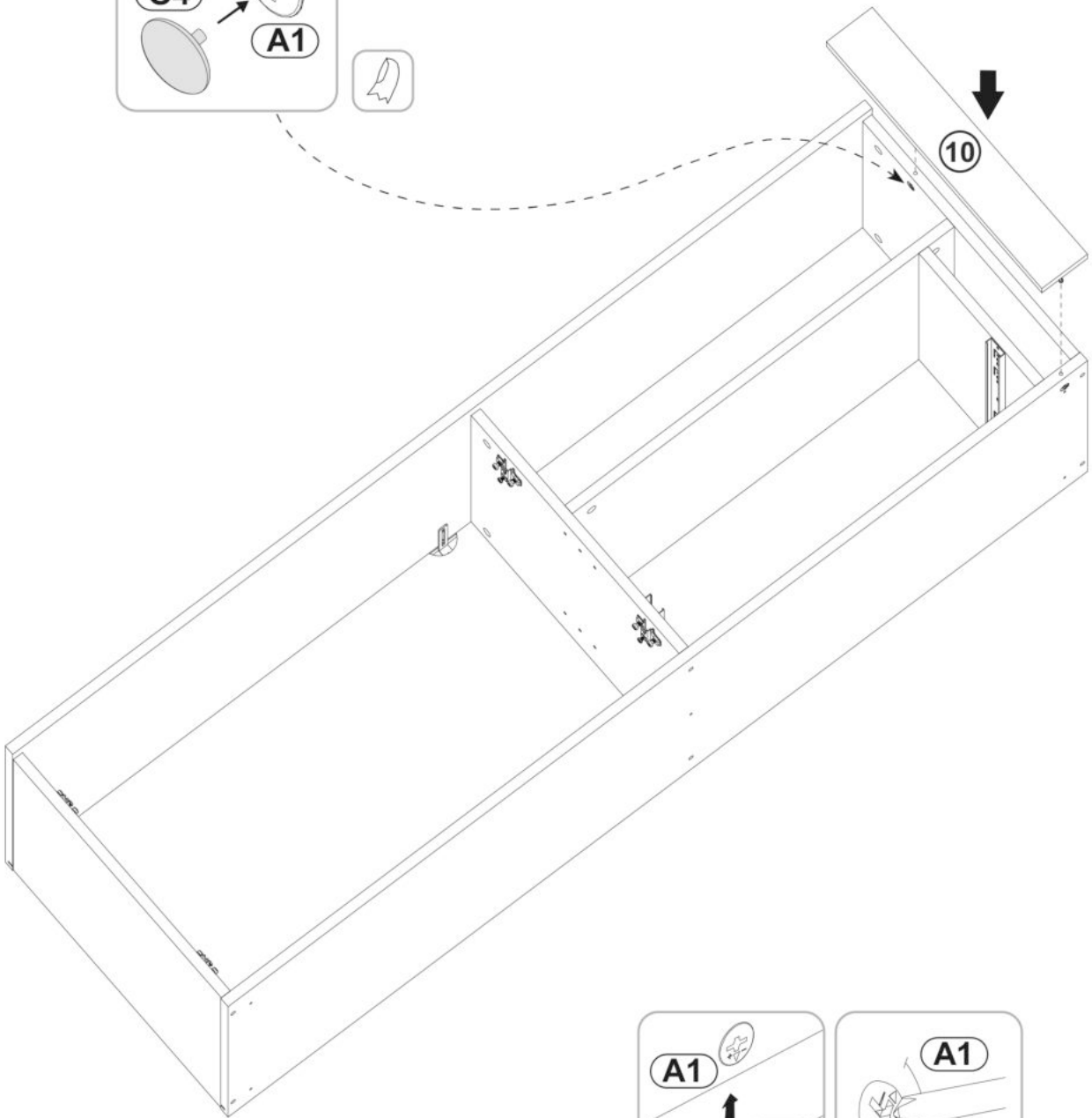
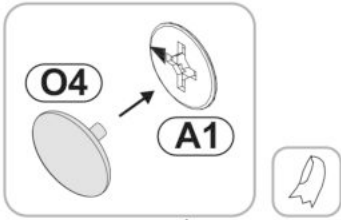

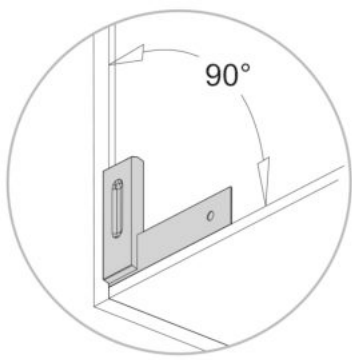
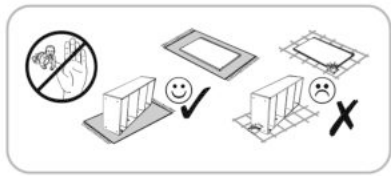



A=B

M1
10x10x15  x10

DA21
4,2x16  x4

P14
45x20  x5

D25
4x25  x5

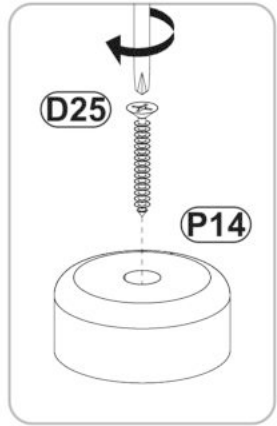
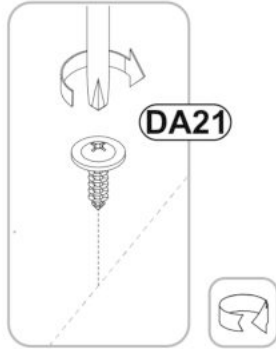
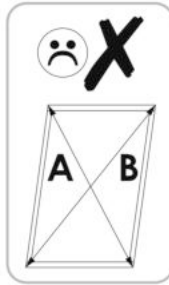
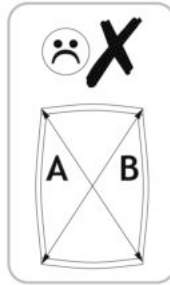
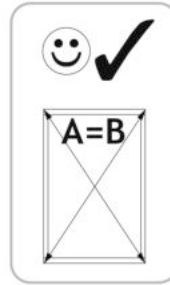
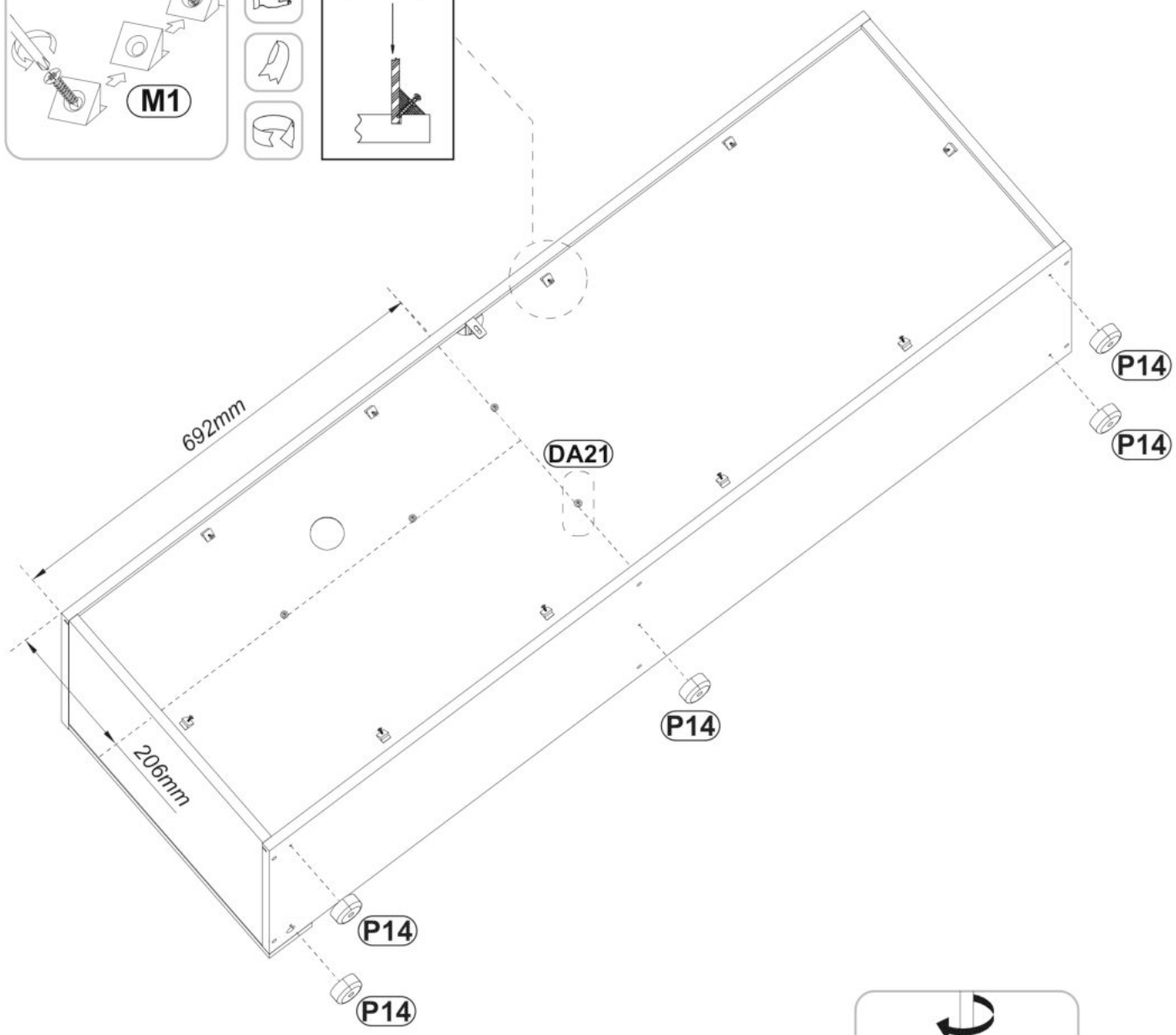
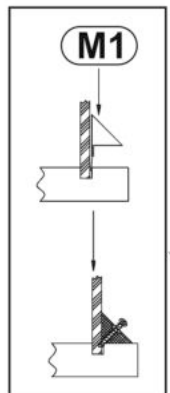
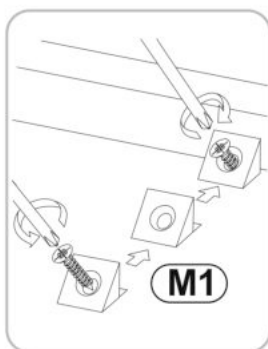

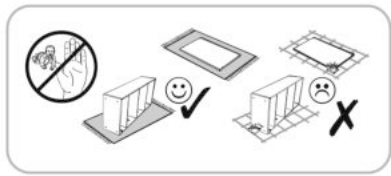

- (N1)** **x4**
Ø6
- (Y37)** **x1**
8x50
- (Y35)** **x1**
4,2x65

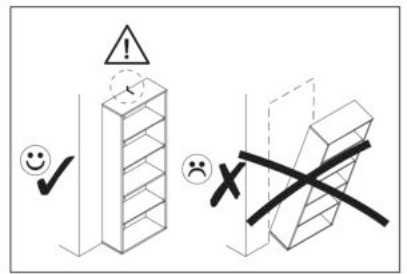
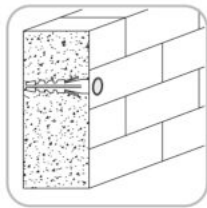
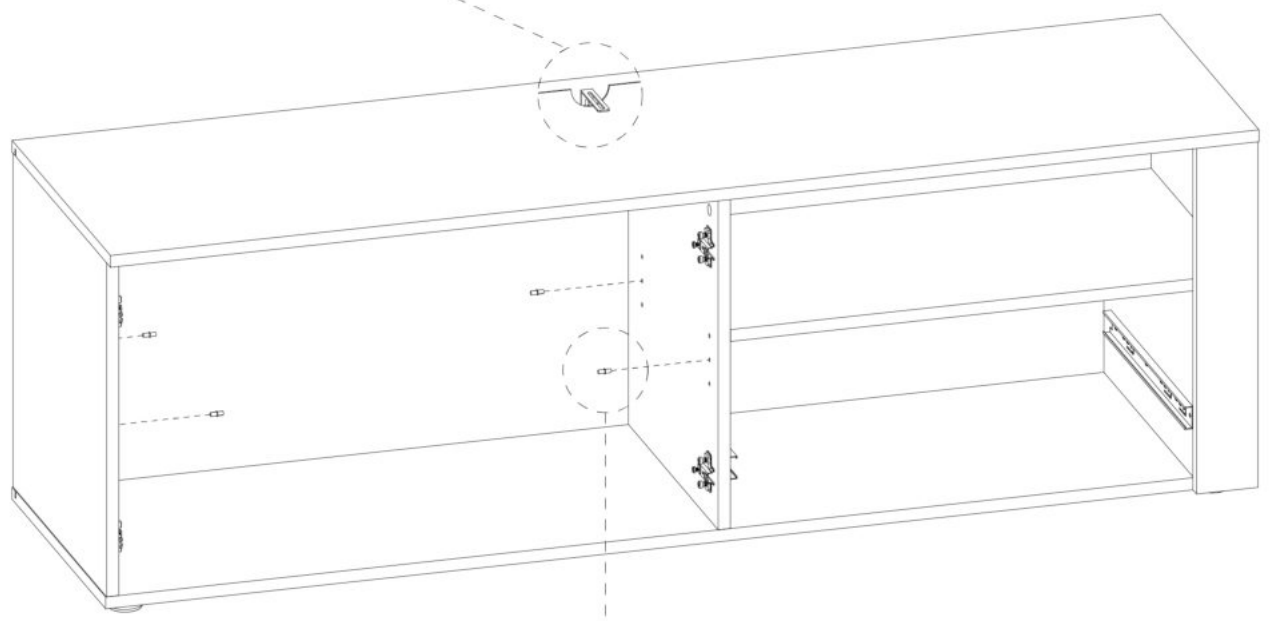
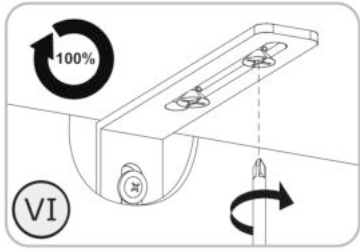
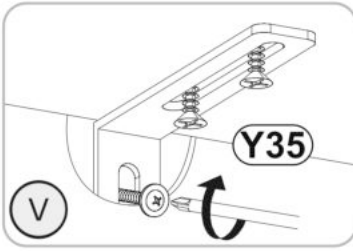
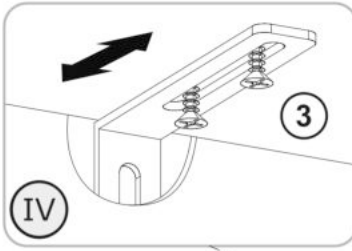
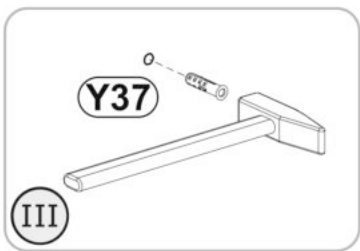
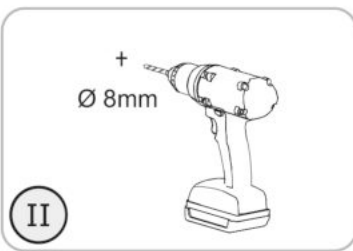
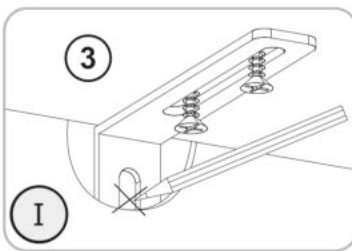

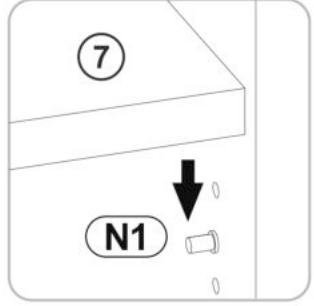
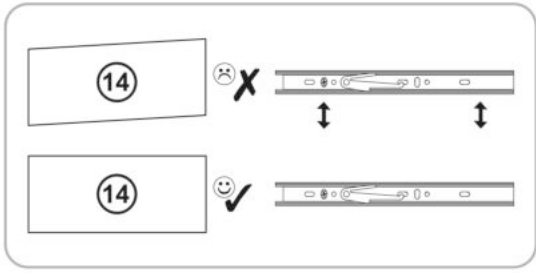
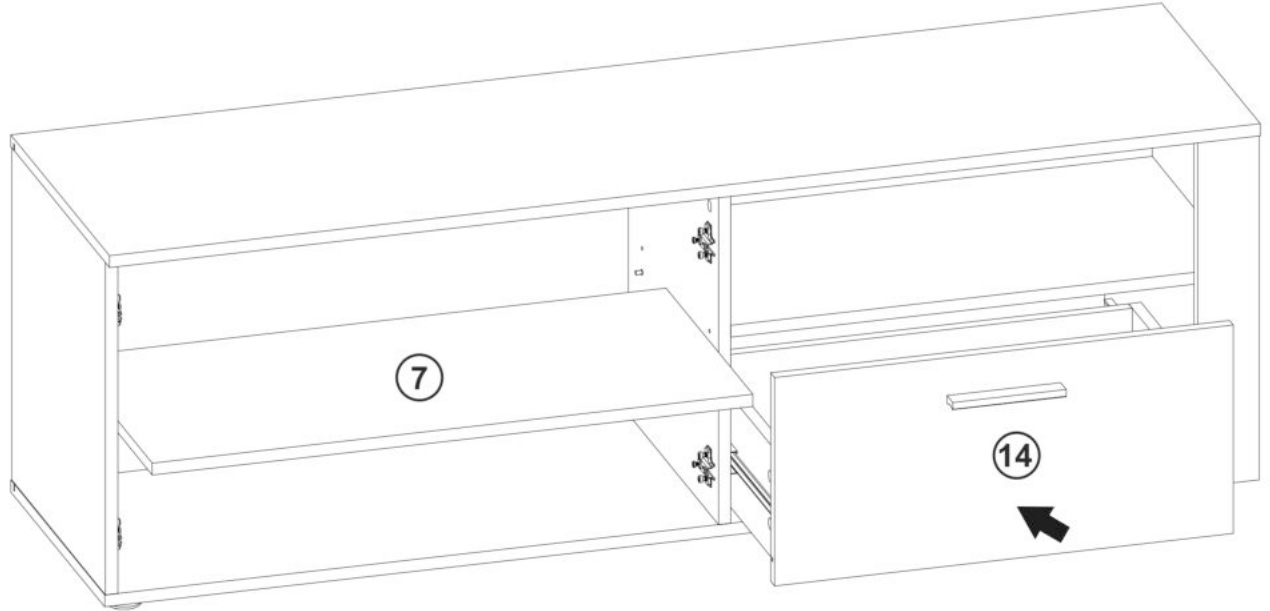
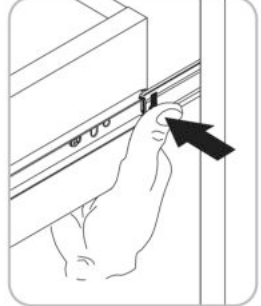
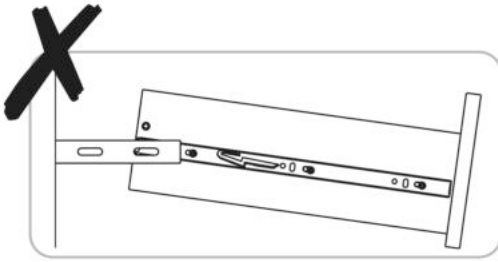
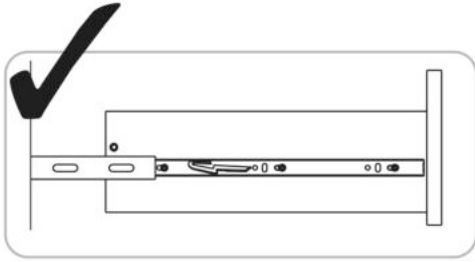
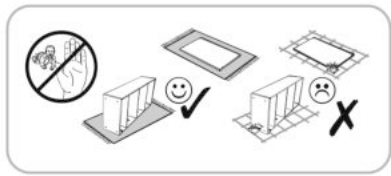

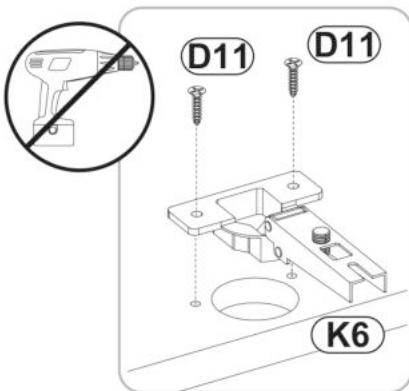
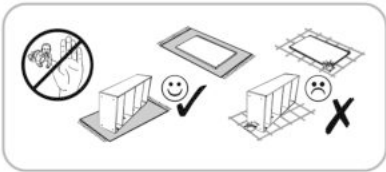

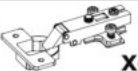
K6
Ø35  x4

D11
3,5x16  x8

DB2
4x25  x2

J65
128/148  x1

R10
Ø10  x2

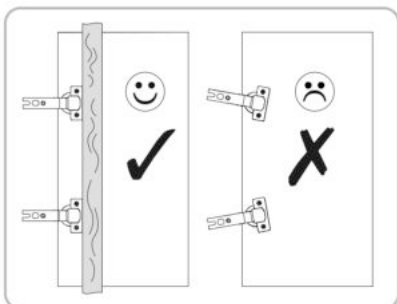
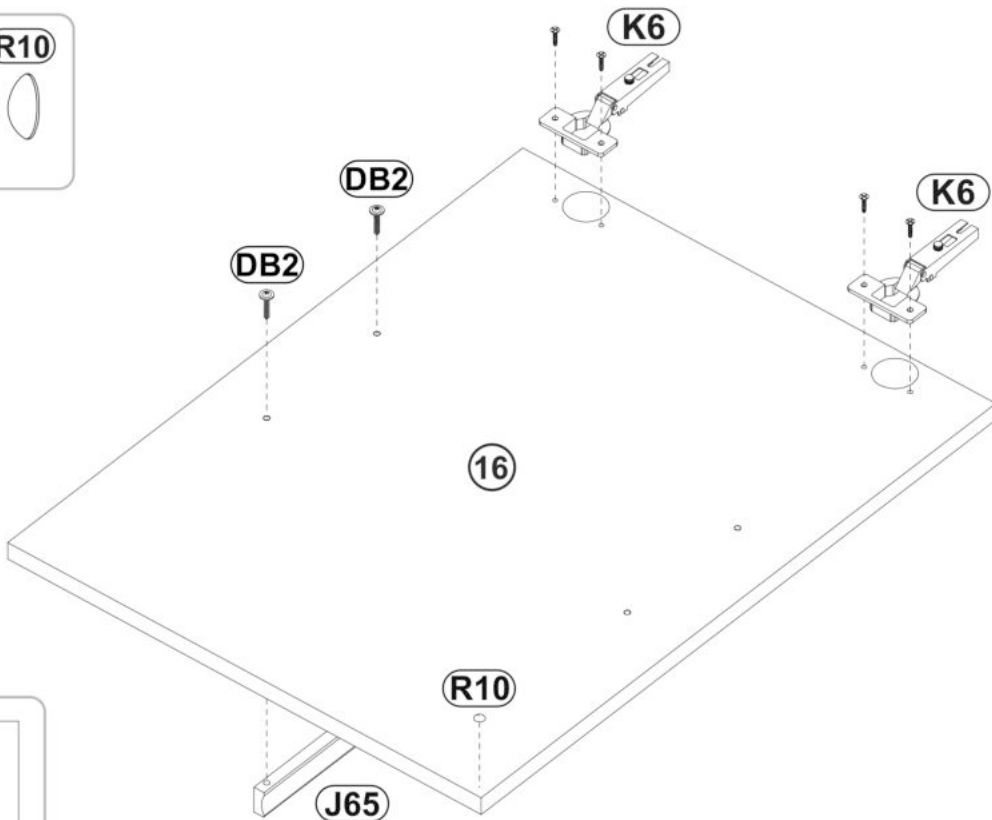
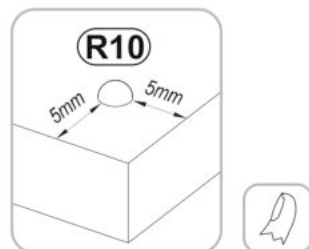
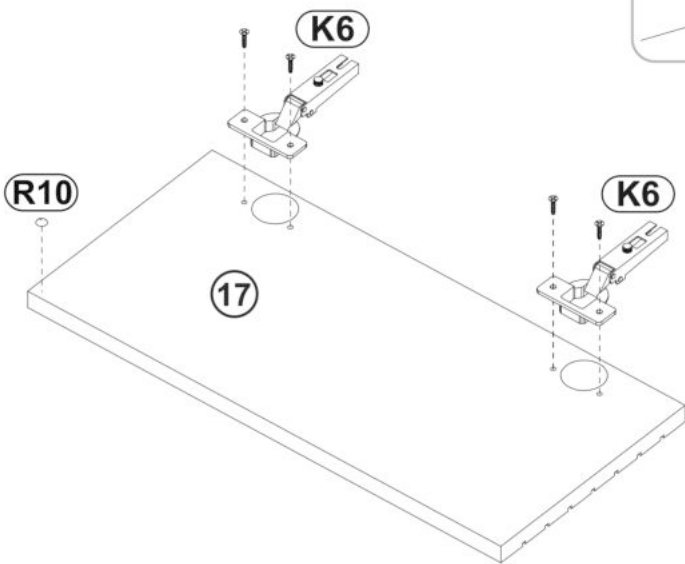

15

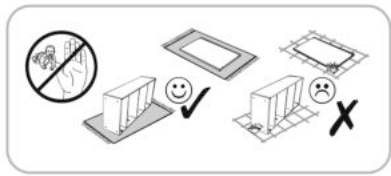

R6  x1

